



# MV Cable Accessories

## CATALOGUE

### GET IN TOUCH

Power Transmission and Telecommunication  
equipment factory co

Jeddah Industrial City: 21482 – Jeddah 8234  
P.O BOX

Tel: +966 1260 95156

Fax: + 966 1260 95156

Email: [sales@pte-sa.com](mailto:sales@pte-sa.com)

[inquiry@pte-sa.com](mailto:inquiry@pte-sa.com)

web: [www.pte-sa.com](http://www.pte-sa.com)



# PREMOLD CABLE ACCESSORIES

SL.NO.	Voltage	Core	Indoor	Outdoor	Joint	Cross section (mm)
1	8.7/15 (17.5) kv	1,3	Yes	Yes	Yes	25-50, 70-120 ,150-240, 300-400, 500-630
2	12/20 (24) kv	1,3	Yes	Yes	Yes	35-70, 95-185,150-300, 400-630
3	18/30 (36) kv	1,3	Yes	Yes	Yes	50-95, 120-185, 240-300, 400-630



# COLD SHRINK CABLE ACCESSORIES



SL.NO.	Voltage	Core	Indoor	Outdoor	Joint	Cross section (mm)
1	0.6/1 KV	1,2,3,4,5	Yes	Yes	Yes	10-16 ,25-50, 70-120, 150-240, 300-400
2	8.7/15 (17.5)KV	1,3	Yes	Yes	Yes	25-50, 70-120 ,150-240, 300-400, 500-630
3	12/20 (24) KV	1,3	Yes	Yes	Yes	35-70, 95-150, 185-300, 400-360
4	18/30 (36) KV	1,3	Yes	Yes	Yes	50-95, 120-185, 240-300, 400-630
5	26/30 (42)KV	1,3	Yes	Yes	Yes	50-95, 120-158, 240-400, 500-630

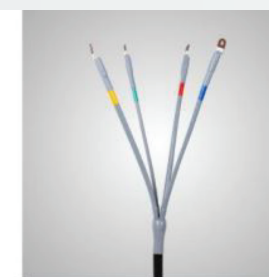
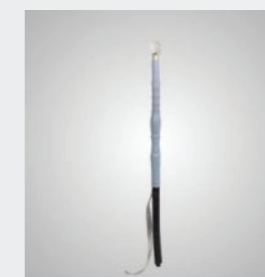
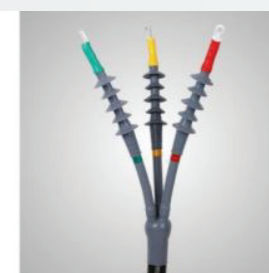
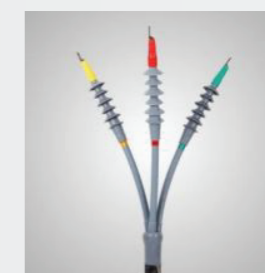
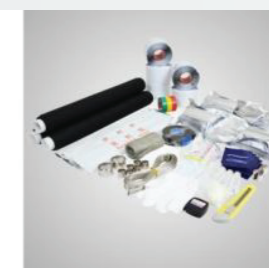
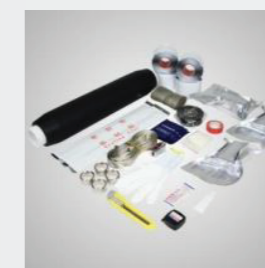

# HEAT SHRINK CABLE ACCESSORIES

# COPPER CONNECTORS

SL.NO.	Voltage	Core	Indoor	Outdoor	Joint	Cross section (mm)
1	0.6/1 KV	1,2,3,4,5	Yes	Yes	Yes	10-16 ,25-50, 70-120, 150-240, 300-400
2	8.7/15 (17.5)KV	1,3	Yes	Yes	Yes	25-50, 70-120, 150-240, 300-500
3	12/20 (24) KV	1,3	Yes	Yes	Yes	35-70, 95-150, 185-300, 400-360
4	18/30 (36) KV	1,3	Yes	Yes	NO	50-95, 120-185, 240-300, 400-630
5	26/30 (42)KV	1,3	Yes	Yes	NO	50-95, 120-158, 240-400, 500-630

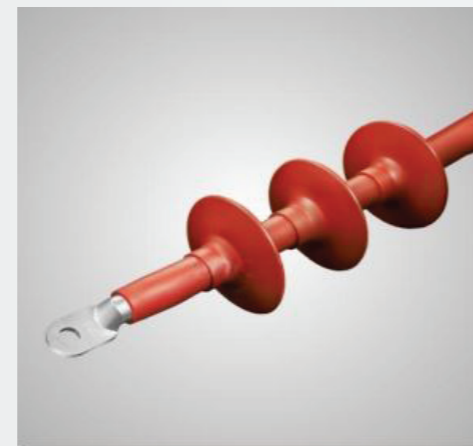

## Dimensions(mm)

SL.NO.	Item Code	Ø1	L	ØT	A	C1	C2
1	PTE - LT - 70	11,5	47,0	8,3	21,5	9,0	8,0
			51,0	10,5	21,5	11,0	10,0
			53,0	13,0	21,5	12,0	11,0
			58,0	14,5	25,0	15,0	13,0
			59,0	16,5	26,0	15,0	14,0
2	PTE - LT - 95	13,5	52,0	8,3	24,7	10,0	9,0
			55,0	10,5	24,7	11,0	11,0
			57,0	13,0	24,7	12,0	12,0
			61,0	14,5	24,7	15,0	13,0
			64,0	16,5	27,0	16,0	15,0
3	PTE - LT - 120	15,8	58,0	8,3	28,9	10,0	9,0
			58,0	10,5	28,9	11,0	10,0
			63,0	13,0	28,9	14,0	12,0
			67,0	14,5	28,9	16,0	14,0
			71,0	16,5	28,9	17,0	16,0
4	PTE - LT - 150	16,5	69,0	10,5	30,4	13,0	11,0
			75,0	13,0	30,4	16,0	14,0
			79,0	14,5	30,4	18,0	16,0
			79,0	16,5	30,4	18,0	16,0
			74,0	10,5	34,0	14,0	11,0
5	PTE - LT - 185	18,8	80,0	13,0	34,0	16,0	14,0
			84,0	14,5	34,0	18,0	16,0
			85,0	16,5	34,0	18,0	17,0
			82,0	10,5	38,4	14,0	12,0
			86,0	13,0	38,4	16,0	14,0
6	PTE - LT 240	21,2	90,0	14,5	38,4	18,0	16,0
			91,0	16,5	38,4	18,0	17,0
			93,0	13,0	41,7	16,0	14,0
			94,0	14,5	41,7	16,0	15,0
			100,0	16,5	41,7	19,0	18,0
7	PTE - LT - 300	23,4	110,0	13,0	47,8	21,0	19,0
			110,0	16,5	47,8	21,0	19,0
			116,0	21,0	47,8	24,0	22,0
			115,0	16,5	54,8	22,0	19,0
			120,0	21,0	54,8	24,0	22,0
8	PTE - LT - 400	26,8	128,0	16,0	64,4	22,0	19,0
			128,0	21,0	64,4	24,0	22,0
			134,0	21,0	64,4	24,0	23,0
			128,0	16,0	64,4	22,0	19,0
			134,0	21,0	64,4	24,0	23,0

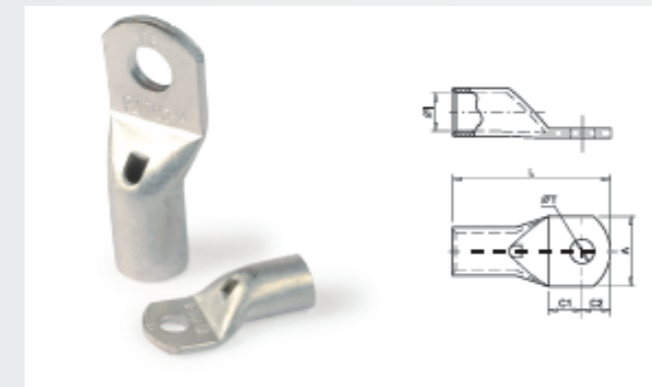

# CABLE CLANDS

SL.NO.	Item Code	SIZE	Overall diameter -A- mm		Length -E- mm	Length (from sholder) -F- mm	Metric Entry Thread -c-	Across Flat Dia. -G- mm	Across Corner Dia. -H- mm
			Min.	Max.					
1	PTE G2 -16	16	4.50	8.50	10	20	16mm	20.00	23.00
2	PTE G2 -20S	20S	8.00	11.50	10	22	20mm	24.00	27.60
3	PTE G2 -20L	20L	7.00	12.00	10	22	20mm	26.00	29.30
4	PTE G2 -25S	25S	11.00	15.50	10	25	25mm	30.00	34.00
5	PTE G2 -25L	25L	14.50	20.00	10	26	25mm	36.00	40.00
6	PTE G2 -32L	32	20.00	26.50	10	28	32mm	40.00	44.40
7	PTE G2 -40S	40S	26.00	31.00	15	29	40mm	51.00	54.80
8	PTE G2 -40L	40L	28.00	33.00	15	29	40mm	51.00	54.80
9	PTE G2 -50S	50S	31.00	38.00	15	30	50mm	56.00	60.00
10	PTE G2 -50L	50L	36.50	44.00	15	31	50mm	60.00	66.40
11	PTE G2 -63S	63S	42.50	52.00	15	31	63mm	68.00	74.40
12	PTE G2 -63L	63L	49.20	56.00	15	31	63mm	74.00	82.60
13	PTE G2 -75S	75S	55.00	62.00	15	33	75mm	80.00	89.00
14	PTE G2 -75L	75L	62.00	86.00	15	33	75mm	85.00	95.00
15	PTE G2 -90	90	66.60	97.50	15	45	90mm	100.00	112.00

